

# ERA-DSRXPG Alarm Kit

## Owner's Manual

This device complies with Part 15 of the FCC rules, Operation of this device is subject to the following conditions: 1. This device may not cause harmful interference. 2. This device must accept any interference, including interference that may cause undesired operation.

### Introduction

The ERA-DSTX is an outdoor rated PIR sensor compatible with all ERA receivers. When the combination of heat & motion are detected, the sensor will transmit a wireless radio signal up to 4,000 ft. to the receiver. This user manual is for the ERA-DSRXPG which includes one outdoor driveway sensor & one plugin receiver.

### Helpful Notes:

- The ERA-DSTX must be programmed to a ERA receiver to function. Programming instructions, settings, & mounting instructions are included in this manual.
- Consult the receiver's user manual for more details & specifications for settings.
- The ERA-DSTX is powered by a 9V alkaline battery (not included).
- Up to 12 ERA-DSTX's may be programmed to a ERA receiver, There's no limit to the number of receivers programmed to the ERA-DSTX.
- It's recommended to choose a different melody for each programmed receiver so you can determine which transmitter triggered the receiver.
- When the transmitter battery is low, it cause the receiver to generate the sound twice in a row.
- Package contents: PIR sensor/transmitter, plate mount, swivel mount, screws (4), plugin receiver, & this user guide.

### ERA-DSTX Sensor Specifications:

- Power source: 9V alkaline battery
- Detection range: low, to 25 ft., medium, to 50 ft., high, to 100 ft.
- Wireless range: up to 4,000 ft.
- Dimensions (HxWxD): 4.5 x 3 x 2.25 inches
- Operating temperature: -30 to 120 F (-34.4 to 48.9 C)
- Operating frequency: 433 MHz

### Setup Steps for Setting Up Sensor/Transmitter:

1. Install a 9V battery (not included). See the section titled "Battery Installation." **Note:** do not re-assemble the case until programming is complete.
2. Pair the sensor/transmitter to the receiver. See section titled "**Pair Transmitter to Receiver.**" **Once you have**
3. Note: some settings of the transmitter may be adjusted as needed. Please see section titled "**Advanced Sensor Settings.**"

### Battery Installation:

1. Remove the four screws on the back of the sensor/transmitter case using a Phillips head screwdriver (figure 1).
2. Remove top half of case from lower case.
3. Install a 9V alkaline battery & place it in the holder (figure 2).
4. See section titled, "**Pairing Transmitter to Receiver.**"
5. **Note:** When battery gets weak, it will cause paired zone to flash LED on receiver for 10 minutes when triggered.

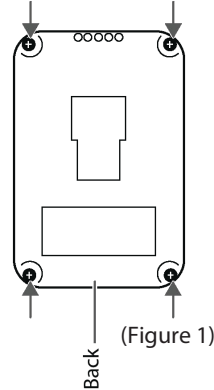

(Figure 2)

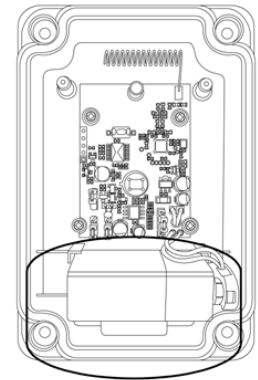

### Pair Transmitter to Receiver:

*(Always test unit prior to installation)*

The transmitter works with the included receiver, the ERA-RXPG, as well as the ERA-DCRX & ERA-VPRX receivers. Basic programming calls for the user to pair the transmitters with a receiver & select a melody for the transmitter to instruct the receiver to play when triggered.

*For quick setup, however, each zone defaults to a basic "ding-dong" sound allowing you to easily pair the transmitter for a faster set up process.*

1. Plug in the receiver (figure 5) into a standard wall outlet.
2. Hold down the "mode" button on the receiver until you hear a short tone sound. A red LED will appear in the strobe lens of the receiver. This denotes programming mode.
3. By default, the receiver is set to play the "ding-dong" sound. To change the melody, press the "volume" button to scroll through the available sounds. Once you hear the melody want, stop pressing the button.
4. Next wave your hand over the "sensor cell" or press the "test" button on the transmitter/sensor (see figure 4).
5. You should hear a quick chime sound denoting successful pairing of the sensor to the receiver. If this is the only sensor/transmitter you are programming, go to the next step. To pair an additional transmitter, repeat steps 3 & 4.
6. To exit programming mode, hold down the "mode" button (figure 5) until you hear a short tone sound (approximately 3 seconds).

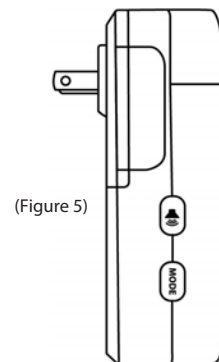

(Figure 5)

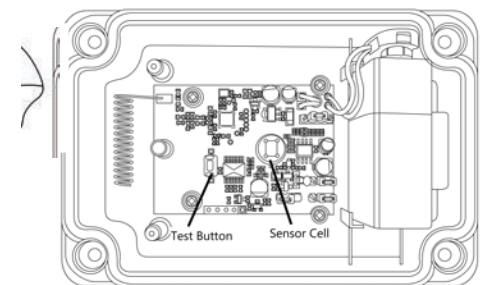

(Figure 4)

## Advanced Sensor/Transmitter Settings:

### Note:

- Remove the battery. Prior to adjusting any sensor settings, please remove the battery. Remove back cover and disconnect the battery. See "Battery Installation."
- Remove / adjust jumper. Jumpers are small black plastic pieces that fit over pins on the circuit board. (figure 5).

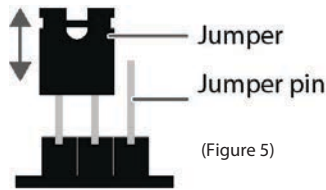

(Figure 5)

- Gently slide the jumper off the pins for the settings you would like to change. If you cannot use your fingers, you can use tweezers.
- Slide the jumper back onto the pair of jumper pins that correspond with the setting you want to change (see images below).

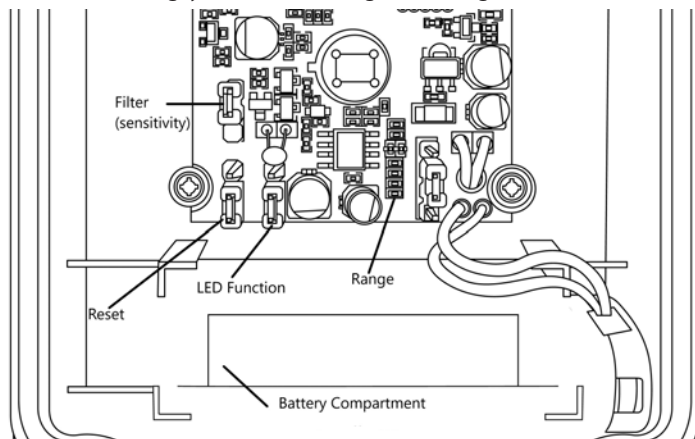

- Range:** Changes the distance that the motion detector will detect motion (size of monitored zone).



- LED:** Turn LED on/off (LED triggered when unit is transmitting radio signal).



- Filter:** Changes the sensitivity level of the motion detector. Recommended OFF for indoor use, ON for outdoor use).



- Reset:** Changed minimum time between alarm activations.

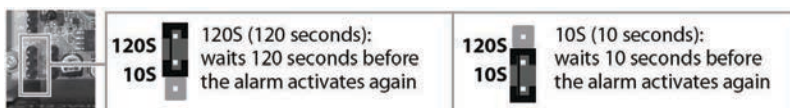

## Mounting the Transmitter:

**Note:** To get the maximum possible range, mount the transmitter/sensor on a wooden or plastic object (if possible & free from obstacles). The range is up to 4,000 ft., but environmental factors may reduce this range.

### Location:

- Try to mount on a wooden post, fence or tree. Avoid mounting on metal if possible.
- Try to mount in a location free of obstacles such as metal siding, trees that may cause transmission interference.
- The product has a very long range, but these obstacles will interfere in the effective range.
- Try to place unit 3-4 ft. off the ground & approximately 20 ft. from either side of driveway or path you are monitoring.
- The sensor will detect people & vehicles up to approximately 100 ft. away (on high setting), & sometimes even farther. For this reason, avoid pointing the transmitter/sensor at roads in the distance.
- Make sure unit is mounted so that it does not move during wind or storms. This could generate false triggers.

### Select a Mounting Bracket:

- Plate mount is ideal for outdoor locations (trees, posts, fence). See figure 6.
- Swivel mount is ideal for indoor locations (figure 6).

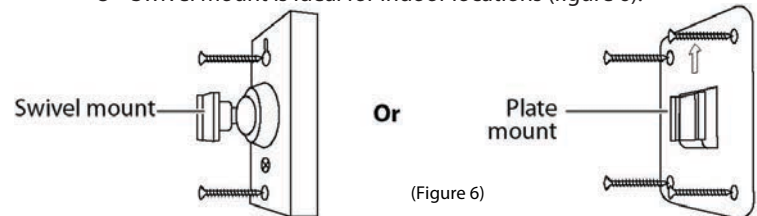

(Figure 6)

### Select a Mounting Bracket:

- Ensure arrow on bracket is facing up.
- Slide transmitter down on bracket. LED on transmitter should be towards the top of the case to function correctly. (figure 7).

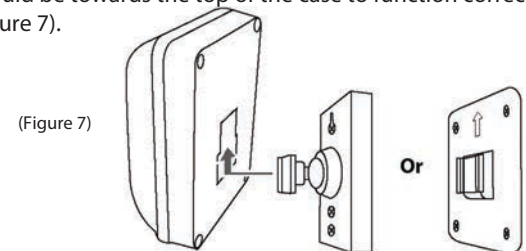

(Figure 7)

## TECHNICAL SUPPORT

If you encounter any difficulty in the operation of this product after reading the manual, please contact us. You can reach us by phone at 904-245-1184 from 8:00 AM to 5:00 PM Monday through Friday (Eastern Standard Time). We will be happy to answer your questions and help you in any way we can.

## WARRANTY

Safeguard Supply warrants this product to be free of defects in material and workmanship for a period of one year from the date of purchase. This warranty does not cover damage resulting from accident, abuse, act of god or improper operation. If this product does become defective, simply return it to Safeguard Supply. Please include a note describing the troubles along with your name and return address as well as the original sales receipt. If the product is covered under warranty it will be repaired or replaced at no charge. If it is not covered by warranty, you will be notified of any charges before work is done.

**Safeguard Supply**  
2260 Moon Station Ct. NW #110  
Kennesaw, GA 30144  
[www.safeguardsupply.com](http://www.safeguardsupply.com)